

# SELECTOR CHART™



## BK

# ADULT ALIGNABLE SYSTEMS

- A** = Angular Adjust
- R** = Rotation
- S** = Slide Adjust
- A** = Aluminum Alloy
- AA** = Aerospace Aluminum
- F** = Foam
- G** = Graph-Lite™
- P** = Plastic
- S** = Stainless
- T** = Titanium
- W** = Wood

### STOCK NUMBERS

- Ø. RB-T
- 4. RSC-FB..... **F**
- 5. TSC-BX..... **AA**
- 11. GUPT-MLAM..... **T**
- 15. GUPT-M4H..... **T**
- 17. GUPT-FPLYON-8 .... **T**
- GUPT-FPLYON-12 .. **T**
- GUPG-FPLYON-8.... **G**
- GUPG-FPLYON-12.. **G**
- 18. GUPG-PLYON-8..... **G**
- GUPG-PLYON-12.... **G**
- TTT-17 ..... **A**
- 19. GUPT-FCLAMP ..... **T**
- 33. TPG-ØMFC..... **G**
- 35. TAJ-Ø1..... **AA**
- 37. TFF-Ø1XXR/L ..... **F**
- 42. GPP-ØØ ..... **P**
- 44. GUPT-SACH1ØM .... **T**
- 45. GUPT-SACH8M ..... **T**
- 46. TGA-ØØ ..... **G**
- 48. TAJ-ØØ ..... **AA**
- 50. TFF-ØØXXR/L..... **F**
- 51. TAJ-CLNUTXXX\*.... **AA**
- 52. TAJ-CLØØ2XXX\* ... **AA**
- 53. TAJ-MPYRNUTXXX\* **AA**
- 54. TAJ-MPYRØØ2XXX\* **AA**
- 55. TPP-ØØ..... **P**
- 56. TFF-RHYTHMFOOTXX **F**
- TFF-RHYSHELLXXR/L **F**

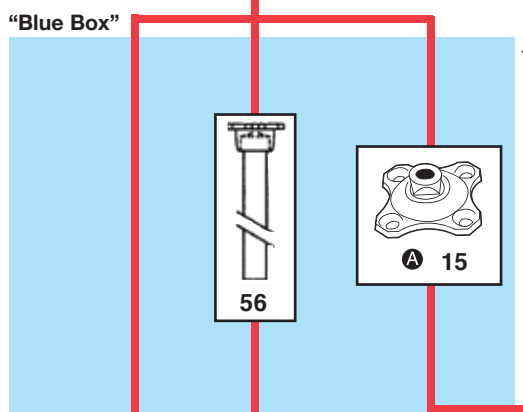
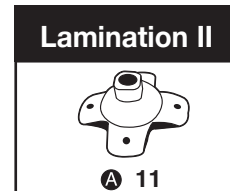
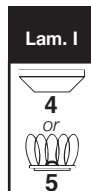

Opt. Distal Attachments for TSK-HØØØ & TK-HØØØ

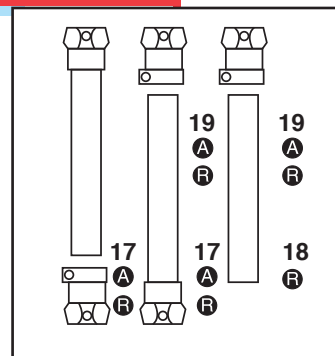
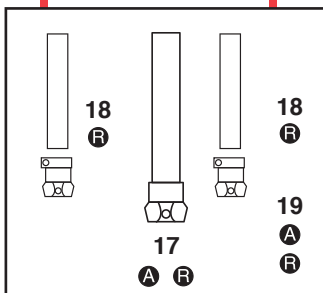

\* Patients up to 130 lbs (60 kg) xxx = Ø6Ø  
 " " " 175 lbs (80 kg) xxx = Ø8Ø  
 " " " 220 lbs (100 kg) xxx = 1ØØ

xx = size

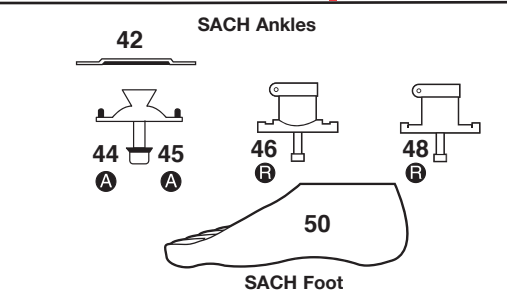
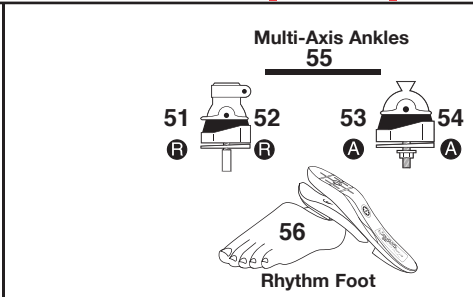
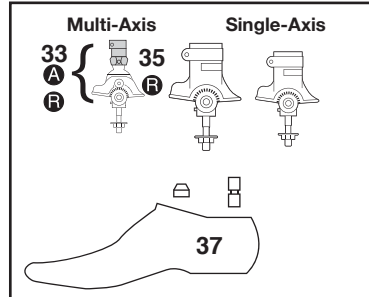

**DAW INDUSTRIES**