

PRACTITIONER'S MANUAL

DAW Industries

SLK Multi-Matrix™ 2.5

Polycentric Self-Learning Microprocessor

Stock #: T GK-5PS0SLKMTX

IMPORTANT:

Adjusting alignment beyond recommended limits described within will adversely affect patient's gait, and could cause premature wear.



HEADQUARTERS:
6610 Nancy Ridge Road
San Diego, CA 92121-2252
Orders: (800) 252-2828 • (858) 622-4962
Fax: (800) 856-8563
www.daw-usa.com

Technical Support
(800) 242-8669

**CENTRAL/EASTERN
DISTRIBUTION CENTER:**
5579-B Chamblee Dunwoody Road
Suite 227
Atlanta, GA 30338-4154
Orders: (800) 824-7192
Fax: (800) 865-8563



SLK Multi-Matrix™ 2.5

Polycentric Self-Learning Microprocessor Knee

Stock #: T GK-5PS0SLKMTX

Benefits:

- ✓ 1-Step Programming
- ✓ Intelligent Variable Cadence
- ✓ Custom-ICR™ Geometric Stability Adjustment
- ✓ Natural Polycentric Toe-Clearance in Swing
- ✓ Ultra-Lite Carbon Fiber Construction
- ✓ Precise Adjustability of Stance Flexion Stability
- ✓ Trouble-Free Zero Maintenance
- ✓ Proven Durability & Dependability



Popular Proximal Options

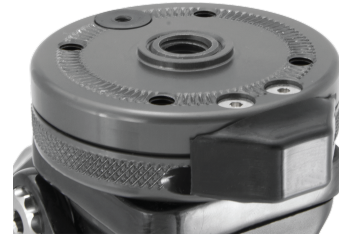

Lo-Pro Rotator™

(#: TKR-01)

Provides Rotational Adjustment
Attach any 4-Hole connector

Suggested L-Codes*: **L5984**



4-Hole Female Pyramid w/ Rotation, Titanium (#: GUPT-F4HROT)

Provides Angular & Rotational Adjustment

Browse our complete selection of Unique Components at

daw-usa.com/all-connectors

Recommended K3 Foot



K3 Pro-Action™ Foot

Engineered for the low to moderately active K3 Individual

Provides 3 Dynamic Energy Returning Carbon Keel Options
& Multi-Axial Ankle Motion with Rotation.

Suggested L-Codes*: **L5981** **L5986**

*Please refer to the complete reimbursement disclaimer at www.daw-usa.com

IMPORTANT:

Read technical information
thoroughly before using knee unit.



DAW®
Industries

© Copyright 2021, DAW Industries, San Diego, CA - All Rights Reserved 01272021



DAW®
Industries

© Copyright 2021, DAW Industries, San Diego, CA - All Rights Reserved 01272021

Specifications

Patient profile:

Body weight	Under 275lb (125kg)
Functional level	K3 /K4
Amputation level	Transfemoral, Bi-lateral or Hip Disarticulation

Knee Specifications:

Stock number	TGK-5PS0SLKMTX
Max weight limit	275lb (125kg)
Knee weight	2.4lb (1095g)
Swing control	Microprocessor Controlled Swing
Stability controls	Microprocessor Controlled Stance, Custom-ICR™ Stability Adjustment & Stance Flexion Stability
Proximal connection	M6 threaded 4-hole or, Unthreaded single hole
Distal connection	30mm tube clamp
Warranty	2 years, upgrade for additional 3 years

Contents

	Page #
Build Height	2
Torque Settings	2
Alignment	3
Why is Custom-ICR Better?	4
Custom-ICR Adjustment	5
Stance Flexion Adjustment	6
Extension Assist Adjustment	7
Matrix Selection Chart	8
Entering Your Desired Matrix	9
Proximal Connectors Selection Guide	10-11
Recommended Foot	12
Patient's Use of the Remote	13
Replacing or Trimming the Extension Assist Spring	14
Stairs, Ramps and Stumble Control Function	14
Foam Covers	15
DAWSkin	16
DAW Prosthetic Knee Limited Warranty	17
Troubleshooting	18
Helpful Hints	19
Specifications	20
Popular Proximal Options	(inside back cover)

BUILD HEIGHT

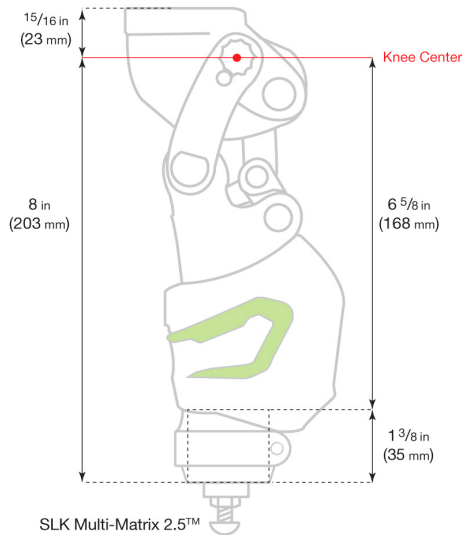

TORQUE SETTINGS

Important:

Use blue Loctite™ 242 on all screws referenced here.

It is not recommended to use Ottobock Titanium Pylon. Do not use a spacer for height adjustment. Ensure pylon is cut straight.

It is recommended these torques be checked within 30 days and then 6 months after your delivery of this prosthesis.

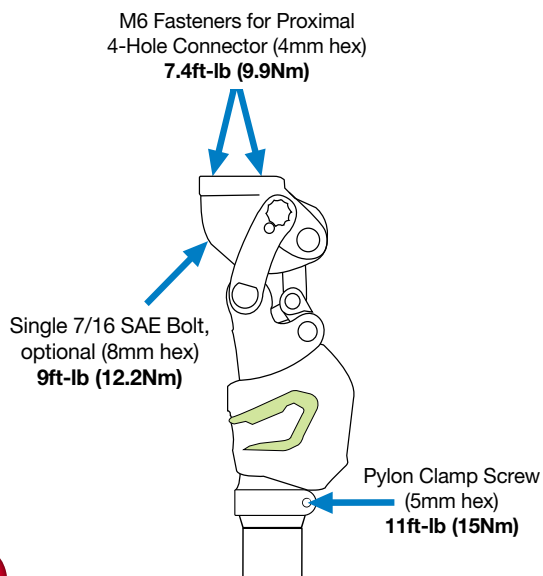

Helpful Hints

DO

- ✓ Use Loctite™ 242 on all screws that can come loose.
- ✓ Use a torque wrench when tightening all screws to the recommended torque setting.
- ✓ Use only the knee connector bolt supplied with the knee unit.
- ✓ Refer to this technical manual at all times.
- ✓ Contact Technical Support at (800) 242-8669 with any questions.

DO NOT

- ✗ Force or “jimmy” any parts together, all components should fit together properly, contact Technical Support for assistance.
- ✗ Integrate with other manufacturers components the without first reviewing with Technical Support.
- ✗ Fit on patients in excess of knee’s max weight limit.
- ✗ Do any maintenance on this knee without first reviewing with DAW Industries.
- ✗ Disassemble any portion of this knee component (unless expressly described in this manual) as it will void the warranty.
- ✗ Use excessive powder inside of foam cover.

NOTE

After aligning the prosthesis, be sure the socket is not limiting knee flexion, otherwise the bumper flexion socket bumper should be added

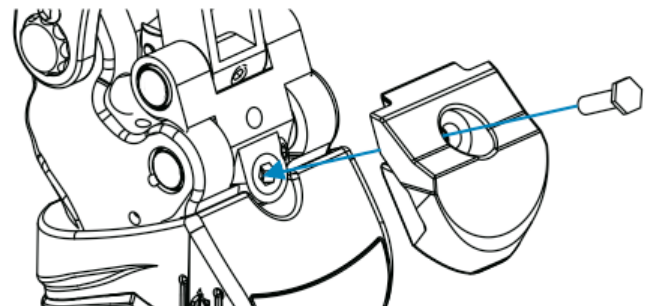

Trouble Shooting

Symptom	Solution	Page
Terminal Impact	1. Check minor adjustment of the extension flexion	7
	2. Adjust, cut, or remove extension spring.	14
No Swing Phase Dampening Control	1. Check battery 2. Check that wireless monitor is on "Auto: Yes"	13
Clicking, Grinding, or Squeaking Noise	1. Remove, clean, and/or replace extension spring.	14
Pylon Turning	1. Tighten pylon clamp to 11ft-lbs 2. Invert pylon 3. Some other manufacturers diameters not to spec (frequent problem with O.B.) 4. Replace pylon (undersized)	2
Pylon is too tight	1. Replace pylon (oversized)	2

RECOMMENDED BENCH & STATIC ALIGNMENT

Standard alignment procedure must be observed to obtain the maximum benefits offered by this knee. All alignment references should be taken from the center of the anterior superior knee axis (commonly referred to as the Knee Center).

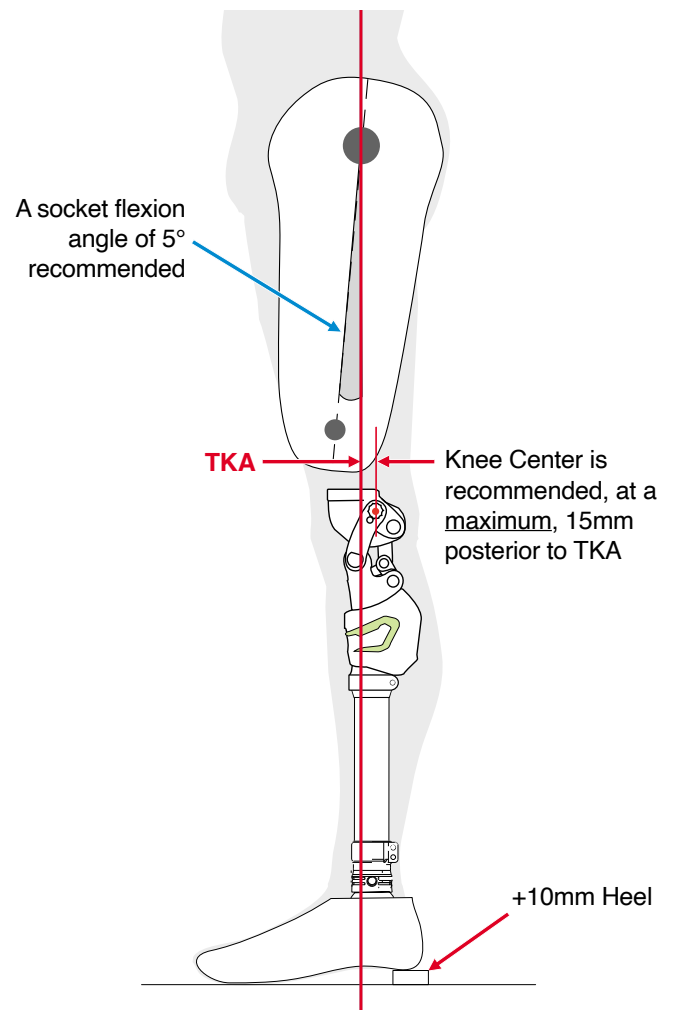

Why is Custom-ICR Better?

Improve Stability without Altering Alignment

Without altering your alignment, the Custom-ICR™ Stability Adjustment optimizes the location of this knee's ICR to optimize stability and minimize energy consumption (see next page to optimize your Patient's Custom-ICR setting).

Watch the "Custom-ICR Setting" video at daw-usa.com/videos

What is a 4-Bar Knee's ICR? And why is its location important?

A Polycentric knee's **Instantaneous Center of Rotation** or **ICR** is a theoretical point located at the intersection of 2 lines which pass through the axes and continue proximally (see fig. below).

The **ICR** location of any polycentric knee determines two factors:
 The knee's Level of Inherent Stability in stance phase
 Your Patient's energy consumption.

Why is an Adjustable ICR Position advantageous?

A traditional 4-Bar knee's **ICR** location is not adjustable. If it is located too far posterior for your Patient's individual biomechanics, your Patient will consume excessive energy.

With this 5-Bar Custom-ICR knee, your Patient will consume the absolute minimum amount of energy.

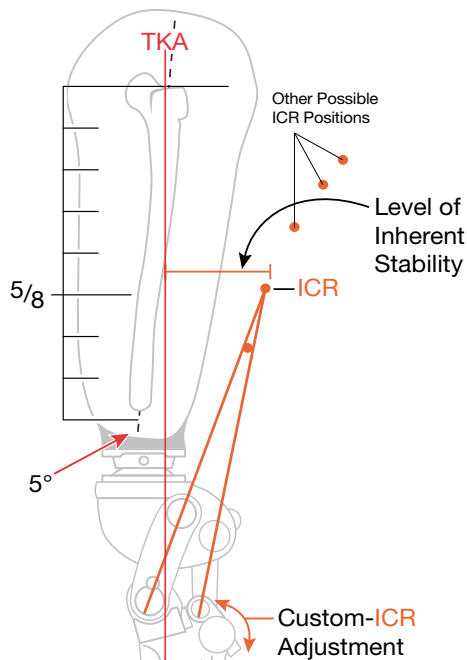

The optimal location of the **ICR** is the area where the Amputee applies force to their socket wall during stance phase. It is most commonly, $\frac{5}{8}$ down the length of the femur.



For Technical Support call (800)242-8669

© Copyright 2021, DAW Industries, San Diego, CA - All Rights Reserved 01082021

DAW Prosthetic Knee Limited Warranty

The knee comes with a Limited Warranty for 2-years. It covers manufacturer defects (excluding wear & tear). An additional 3 years of warranty coverage can be purchased for +15% of the original cost of the knee. See full warranty statement at: www.daw-usa.com/practitioner-resources/

Weight limit of this knee is 275lb (125kg)

Bumpers are not under warranty.

Tight screws and a straight cut of the tubing are a must. Not following recommended use of components, including weight limit and alignment, will void the warranty. Make sure to read all instructions enclosed with the knee unit.

All repairs on the knee module must be done by a factory-trained DAW technician. Any disassembly done on the knee during the warranty period(s) will void the warranty (excluding disassembly of the extension spring housing).

Service Under Warranty

For all component repairs call DAW Industries right away. We will ship a replacement knee the same day, which will become your patient's new knee. The replacement component is under warranty for the time remaining on the original component.

The overnight shipping charge will be credited upon receipt of the failed knee component.

Service Outside of Warranty

Knees not under warranty may be repaired by DAW. While any unwarranted knee is being serviced, DAW will provide a rental knee subject to availability. The DAW rental fee is listed in the price list under each knee. The rental fee covers the period DAW takes to complete the repair with ten (10) days allowed for shipping in both directions. The same rental fee will be charged every 30 days passed the initial rental fee period.

For any repair you must first contact our Technical Services at 1(800)242-8669. This will allow DAW to best understand the issue. Our Technical Support will immediately assess if the repair qualifies as a "minor" or "substantial" repair. A "minor" repair will be completed, as a courtesy, free of charge (you will just pay for return shipping). A "substantial" repair will be billed at a flat rate according to knee model. Upon return of your repaired knee, you will be invoiced for the repair charge, if any. When DAW receives the rental knee, your account will be credited for the value of the returned knee (Gold Preferred+ = FREE rental; Preferred = 33% off).

In the event your knee is unrepairable, you will be notified immediately. The rental must then be returned to DAW, 2nd day, within five (5) working days. The rental fee may be applied toward the purchase of a new DAW knee.



For Technical Support call (800)242-8669

© Copyright 2021, DAW Industries, San Diego, CA - All Rights Reserved 01082021

DAWSkin™ Protective Cover System

Benefits:

- Off the Shelf.
- BK, AK and Discontinuous 2-Part AK to choose from.
- Slips on and off easily.
- Soft, flexible and durable.
- Skin-like texture and feel.
- Does not interfere with function of knee.
- Seven skin tones + 1 Graphite Black
(Blush, Fair, Caucasian, Suntan, Dark Suntan, Light Black, Black)

DAWSKIN & DAW^{toe}SKIN STANDARD & MEGA-STRETCH SIZING CHART

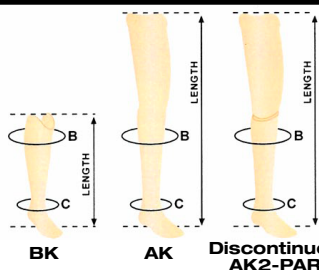

- BK, AK and 2-Part AK to choose from.
- Slips on and off easily.
- Soft, flexible and durable.
- Skin-like texture and feel.
- Does not interfere with function of knee.
- Nine skin tones + Graphite Black:
(Blush, Fair, Shell, Cream, Caucasian, Suntan, Dark Suntan, Light Black, Black, Graphite Black)

SKIN SIZE CIRC.	ADOLESCENT	PETITE	SMALL	MEDIUM	LARGE
	14 to 19 cm	20 to 25 cm	21 to 24 cm	25 to 27 cm	28 to 30 cm
B	1/8 to 1/4 (23 to 26 cm)	11 3/4 to 13 in (29 to 33 cm)	12 3/4 to 14 1/4 in (32 to 36 cm)	14 to 16 1/4 in (35 to 41 cm)	16 1/2 to 18 3/4 in (41 to 47 cm)
C	5 1/4 to 7 in (13 to 18 cm)	7 1/4 to 8 1/2 in (18 to 21 cm)	8 1/2 to 9 1/2 in (21 to 24 cm)	9 to 10 1/4 in (22 to 26 cm)	9 3/4 to 11 1/2 in (24 to 29 cm)
LENGTH	BK 20 in (50 cm) AK 27 in (68 cm)	BK 20 in (50 cm) AK 29 in (73 cm)	BK 21 in (53 cm) AK 29 in (73 cm)	BK 23 in (58 cm) AK 31 in (78 cm)	BK 24 in (60 cm) AK 34 in (85 cm)

PRODUCT AVAILABILITY	BK	AK	AK2-PART
DAWSKIN ORIGINAL	ALL SIZES	ALL SIZES	NO
DAWSKIN MEGASTRETCH	ALL SIZES	ALL SIZES	ALL SIZES
DAW ^{toe} SKIN MEGASTRETCH	ALL SIZES (except petite & adolescent)	ALL SIZES (except petite & adolescent)	ALL SIZES (except petite & adolescent)
DAWsplitSKIN MEGASTRETCH	ALL SIZES (except petite & adolescent)	ALL SIZES (except petite & adolescent)	ALL SIZES (except petite & adolescent)



MEDICARE L-CODES

- BK: L 5962 – Addition, Endoskeletal System, Below Knee Flexible Protective Outer Surface Covering System.
- AK: L 5964 – Addition, Endoskeletal System, Above Knee Flexible Protective Outer Surface Covering System.



For Technical Support call (800)242-8669

Custom-ICR Adjustment

For help with this adjustment, watch the “Custom-ICR Setting” video at daw-usa.com

- ↳ Product Support
- ↳ Videos

During bench or static alignment:

1. Loosen the Set Screw (2mm hex)
2. The factory Custom-ICR setting is set for an Amputee with an 8-inch residual femur. To adjust the Custom-ICR setting to your patient’s residual femur length, turn the Custom-ICR Adjustment (5mm hex):

1/4 turn clockwise for every inch of femur shorter than 8.

Or...

1/4 turn counter-clockwise for every inch of femur longer than 8.

3. Retighten the Set Screw before dynamic alignment.

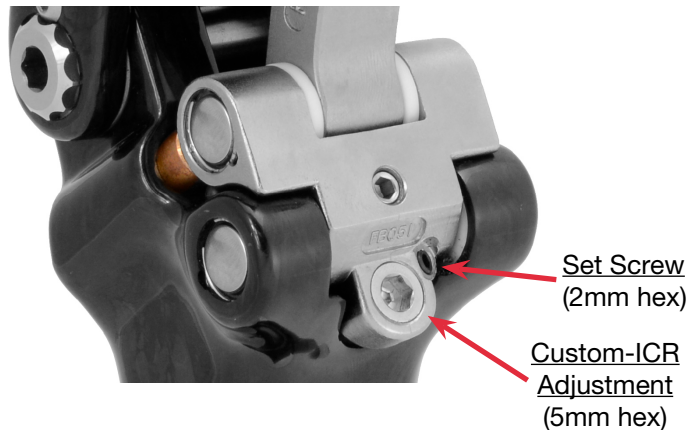

During dynamic alignment:

Adjust the setting to your Patient’s weak or strong hip extensor strength.

Turn clockwise to provide more stability to compensate for weaker hip extensors

Or... If patient is hanging up in swing phase,

Turn counter-clockwise to provide more efficiency to a Patient with stronger hip extensors.



For Technical Support call (800)242-8669

Stance Flexion Adjustment

IMPORTANT:

RED TABS should be removed before dynamic alignment.

General Stance Flexion Adjustment:

Equally turn the Stance Flexion Adjustment Screws:

Counter-Clockwise for less resistance to Stance Flexion
(and a higher max Stance Flexion Angle)

Clockwise for more resistance to Stance Flexion
(and a lower max Stance Flexion Angle)

RED TABS – What are they for?

The red tabs allow you to accurately adjust to the Maximum Stance Flexion setting while ensuring full contact remains between the Middle Posterior Axis and the Brass Cylinder given your current Custom-ICR™ Stability setting.

To Provide Maximum Stance Flexion:

- One at a time, turn the Stance Flexion Adjustment Screws **counter-clockwise** until the Red Tabs pull out easily (Fig.1).
- Now turn each **clockwise** ¼ of a turn. Adjust equally.

Note:

When adjusting Stance Flexion after **RED TABS** have been removed, ensure each Brass Cylinder remains in full contact with the Middle Posterior Axis (Fig.2).

Fig.1

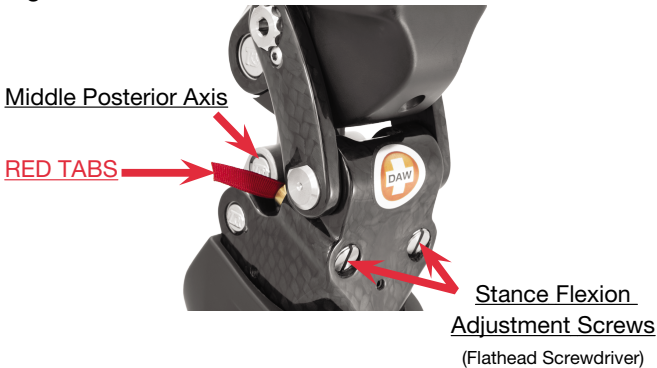
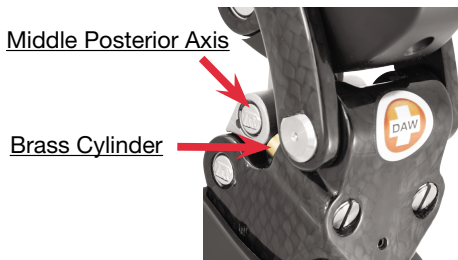

Fig.2 (After Red Tabs Removed)



FOAM COVERS

DAWFLEX™

FUNCTIONAL

- Patented design – Maximum flexion without interference

DURABLE

- Extremely resilient

COSMETIC

- 4 Sizes – easily shaped and modified

VERSATILE

- Adapts to any AK modular system

COST-EFFECTIVE

- Superior cosmesis in a fraction of the time

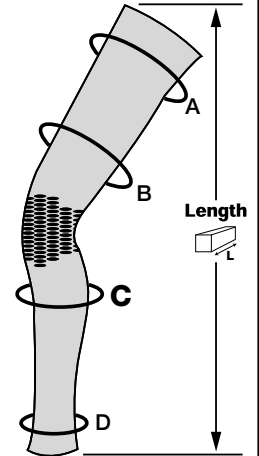

Size	X SMALL	SMALL	MEDIUM	LARGE
RIGHT	TFC-DFXSR	TFC-DFSR	TFC-DFMR	TFC-DFLR
LEFT	TFC-DFXSL	TFC-DFSL	TFC-DFML	TFC-DFLL
A	16 in (41cm)	19 in (48cm)	20 ½ in (52cm)	21 ½ in (55cm)
B	12 ½ in (32cm)	15 in (38cm)	16 ½ in (42cm)	17 ½ in (44cm)
C	11 ¾ in (30cm)	13 in (33cm)	14 ½ in (37cm)	15 ½ in (39cm)
D	7 ½ in (19cm)	8 in (20cm)	9 in (23cm)	10 in (25cm)
Length	29 in (74cm)	33 in (84cm)	35 in (89cm)	37 ½ in (95cm)

Do Not Forget To Order DAWSkin™

TWO-PART DISCONTINUOUS

TFC-EG5POSLKL (left) • TFC-EG5POSLKR (right)

- Exoskeletal durability and cosmesis with endoskeletal light weight modularity.
- No interference with knee function.
- Excellent for knee disarticulation.
- Allows for kneeling without damage to cover.
- Inside is pre-cut for knee.

Each Cover Includes:

- Custom hard foam rubber knee cap.
- Pre-shaped plastazote tibial form.
- Inner soft form “filler” to protect the knee and prevent play between the knee and cover.

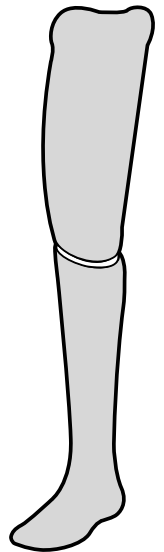

Replacing or Trimming the Extension Assist Spring

How to Shorten, Remove, or Replace

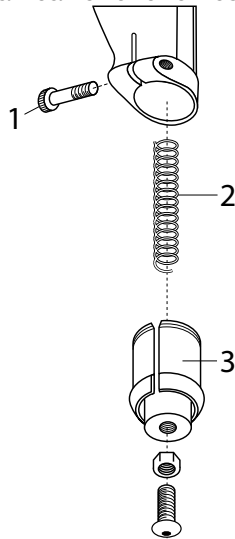

In some instances it may be necessary to shorten the spring or remove it completely on very active patients, or replace the existing spring with a heavier one for less active patients.

1. Remove pylon.
2. Remove pylon clamp screw ① completely with a 5mm Allen key.
3. Gently remove the extension spring housing ③ (flexing and extending the knee will help).
4. Make necessary adjustment to spring (cutting two coils max.).
or...
Replace or remove the spring ②.
5. Replace extension spring housing ③ ensuring the vertical notch is aligned with vertical slot in the unit.
6. Replace the pylon (TTG-14) and pylon clamp screw ①.
7. Tighten the pylon clamp to **11ft-lb (15Nm)**.



Stairs, Ramps and Stumble Control Function

The high resistance that is required for negotiating ramps and stairs is preprogrammed into resistance level 9 of the SLK Multi-Matrix. To utilize these settings properly, the Amputee should walk on the knee for at least 3 days. The recommended training for an Amputee for ramps & stairs after 3 days of walking is as follows:

1. Press the  (A/M) button once. Confirm the appearance of a dot in the Top Window.
2. Scroll to level 9 using the up arrow. 
3. Have your patient walk down a slight ramp several times. Once they feel confident on the slight ramp, have them walk on a steeper ramp.
4. After the patient has negotiated the ramps 20 times, they may try stairs. Unless extremely experienced, have them start with stairs that have hand rails.
5. When Ramp and Stair Training is complete, press the  (A/M) button once so the dot in the Top Window disappears. The knee is now in control of the level of resistance and the Amputee can negotiate ramps and stairs.

Extension Assist Adjustment

To Adjust Extension Assist:

- A. Loosen the Pylon Clamp Screw (5mm hex) and remove the Pylon
- B. Loosen the Lock Nut (12mm wrench)
- C. Turn the Extension Assist Control Screw (5mm hex):
Clockwise to increase extension assist
Counter-clockwise to decrease extension assist
- D. Re-tighten the Lock Nut, **Hand Tighten** (12mm wrench). After returning the pylon, re-tighten Pylon Clamp Screw to **11ft-lb (15Nm)**.

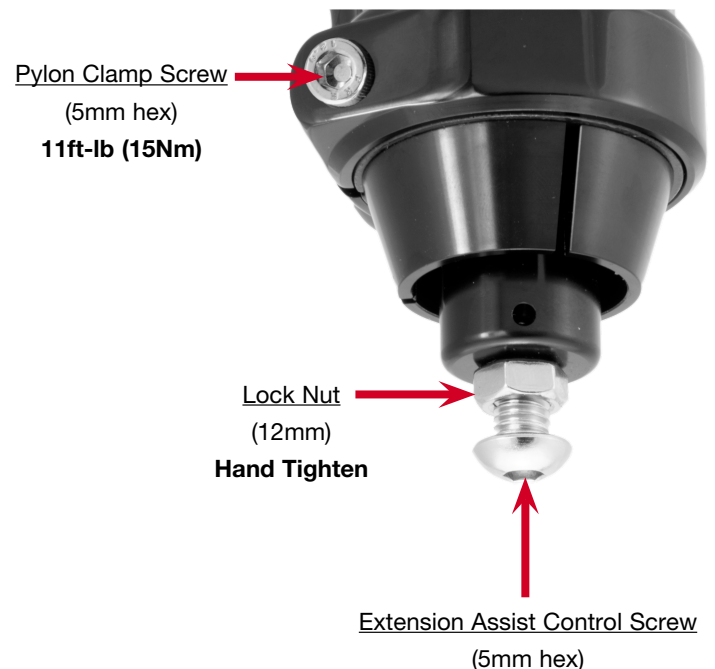

3D MATRIX SELECTION CHART

MATRIX 1

PATIENT PROFILES:

WEIGHT (lb)	ACTIVITY	LENGTH
220-275	SELECT MATRIX 3	
180-220	LOW	M to L
140-180	LOW	ALL

MATRIX 1 - EXT./FLEX RESISTANCE MATRIX

IMPACTION*	<40	<80	<120	<160	≥160	0.0-0.3	0.3-0.6	0.6-0.65	0.65-0.7	0.7-0.8	0.8-0.9	0.9-1.0	>1.0
	1	2	3	3	4	4	4	5	5	6	6	7	7
	2	2	3	3	4	4	4	5	5	6	6	7	7
	3	3	3	4	4	4	5	5	5	6	6	7	8
	3	4	4	5	5	5	5	5	5	6	6	7	8
	4	5	5	5	5	5	5	5	5	6	6	7	8
GAIT m/s VELOCITY	0.0-0.3	0.3-0.6	0.6-0.65	0.65-0.7	0.7-0.8	0.8-0.9	0.9-1.0	>1.0					
		SLOW		MODERATE			FAST						

MATRIX 2

PATIENT PROFILES:

WEIGHT (lb)	ACTIVITY	LENGTH
220-275	SELECT MATRIX 3	
180-220	LOW	SHORT
140-180	LOW	LONG

MATRIX 2 - EXT./FLEX RESISTANCE MATRIX

IMPACTION*	<40	<80	<120	<160	≥160	0.0-0.3	0.3-0.6	0.6-0.65	0.65-0.7	0.7-0.8	0.8-0.9	0.9-1.0	>1.0
	1	2	3	3	4	4	4	5	5	6	6	7	7
	2	3	3	3	4	4	5	5	6	6	7	7	8
	3	4	4	4	5	5	6	6	6	7	7	8	8
	4	5	5	5	6	6	6	6	7	7	8	8	8
	5	5	6	6	6	6	7	7	8	8	8	8	8
GAIT m/s VELOCITY	0.0-0.3	0.3-0.6	0.6-0.65	0.65-0.7	0.7-0.8	0.8-0.9	0.9-1.0	>1.0					
		SLOW		MODERATE			FAST						

MATRIX 3

PATIENT PROFILES:

WEIGHT (lb)	ACTIVITY	LENGTH
220-275	MODERATE	SHORT
180-220	MODERATE	S to M
140-180	MODERATE	LONG

MATRIX 3 - EXT./FLEX RESISTANCE MATRIX

IMPACTION*	<40	<80	<120	<160	≥160	0.0-0.3	0.3-0.6	0.6-0.65	0.65-0.7	0.7-0.8	0.8-0.9	0.9-1.0	>1.0
	2	2	3	4	5	5	6	6	7	7	8	8	8
	2	3	3	5	5	6	6	7	7	8	8	8	8
	3	4	5	5	6	6	7	7	8	8	8	8	8
	4	5	5	6	7	7	8	8	8	8	8	8	8
	5	5	6	6	7	7	8	8	8	8	8	8	8
GAIT m/s VELOCITY	0.0-0.3	0.3-0.6	0.6-0.65	0.65-0.7	0.7-0.8	0.8-0.9	0.9-1.0	>1.0					
		SLOW		MODERATE			FAST						

MATRIX 4

PATIENT PROFILES:

WEIGHT (lb)	ACTIVITY	LENGTH
220-275	MOD/HIGH	M to L
180-220	MOD/HIGH	LONG
140-180	MOD/HIGH	M to L

MATRIX 4 - EXT./FLEX RESISTANCE MATRIX

IMPACTION*	<40	<80	<120	<160	≥160	0.0-0.3	0.3-0.6	0.6-0.65	0.65-0.7	0.7-0.8	0.8-0.9	0.9-1.0	>1.0
	3	4	4	5	5	6	7	7	8	8	8	8	8
	4	4	5	5	6	7	7	7	8	8	8	8	8
	4	5	6	6	7	7	8	8	8	8	8	8	8
	5	5	6	6	7	8	8	8	8	8	8	8	8
	5	6	7	7	8	8	8	8	8	8	8	8	8
GAIT m/s VELOCITY	0.0-0.3	0.3-0.6	0.6-0.65	0.65-0.7	0.7-0.8	0.8-0.9	0.9-1.0	>1.0					
		SLOW		MODERATE			FAST						

MATRIX 5

PATIENT PROFILES:

WEIGHT (lb)	ACTIVITY	LENGTH
220-275	HIGH	ALL
180-220	HIGH	M to L
140-180	HIGH	LONG

MATRIX 5 - EXT./FLEX RESISTANCE MATRIX

IMPACTION*	<40	<80	<120	<160	≥160	0.0-0.3	0.3-0.6	0.6-0.65	0.65-0.7	0.7-0.8	0.8-0.9	0.9-1.0	>1.0
	4	5	5	5	6	6	7	7	8	8	8	8	8
	5	5	6	6	7	7	8	8	8	8	8	8	8
	5	6	6	7	7	8	8	8	8	8	8	8	8
	6	6	7	7	8	8	8	8	8	8	8	8	8
	7	7	7	8	8	8	8	8	8	8	8	8	8
GAIT m/s VELOCITY	0.0-0.3	0.3-0.6	0.6-0.65	0.65-0.7	0.7-0.8	0.8-0.9	0.9-1.0	>1.0					
		SLOW		MODERATE			FAST						





*Impaction is an algorithmic representation of velocities in 3 planes.

Patient's Use Of The Remote (For Selecting Matrix, see page 8)

The SLK's remote allows the patient to wirelessly monitor the charge of the battery and manually adjust flexion resistance of the knee.

To adjust flexion resistance in Manual Mode:

(See fig. a below)

1. Press the  (A/M) button one time, remote will beep once. Verify that a dot has appeared in the lower right-hand corner of the Top Window.
2. Using the   (up/down) arrows scroll to the desired resistance level.
3. Pressing the  (A/M) button again will return the SLK to Auto Mode, the dot in the Top Window will disappear.

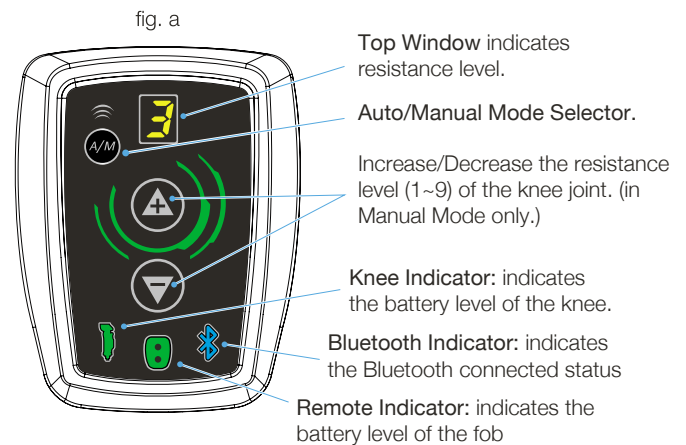

Monitoring battery charge level:

Bluetooth Indicator is:
Blue (connected)
Blinking blue (pairing)

Knee/Remote Indicator is:

Green (knee is fully charged)
 Blinking Green (25% charge, 7 1/2 hours remaining)

If motionless for 2 minutes the knee and remote will enter sleep mode, and power down. Press any button to wake up the remote, bend the knee to wake up the knee.

NOTE:

An unused fully charged battery can lose its charge after one month. All unused batteries should be completely discharged and stored in a cool dry place.

Recommended Foot

PRO-ACTION FOOT™



- ✓ Dynamic energy return, Multi-Axis Ankle w/ rotation
- ✓ 3 split carbon keel stiffnesses: A, B, or C
(see keel selection chart to the right)
- ✓ Adjustable dorsi and plantar flexion
- ✓ Sizes 22-28
- ✓ Caucasian or Light Black foot shells
- ✓ Includes: foot shell, spectra sock, 3 bumper durometers

KEEL SELECTION CHART

Limb Length (select one)	0 to 4"	0
	4 to 6"	1
	6 to 8"	2
	8 to 11"	3
	11" and up	4
Muscle Strength (select one)	Moderate	1
	Strong	2
	Powerful	3
Activity (select one)	Low	1
	Medium	2
	High	3
Patient Weight (select one)	up to 100lb	0
	100 to 150lb	1
	150 to 200lb	2
	200 to 250lb	3
	250 to 300lb	4
Add Scores For Keel Selection	2 to 7	Stiffness A
	8 to 12	Stiffness B
	13 to 14	Stiffness C

Entering The Desired Matrix Using Remote (Prosthetists Only)

The knee is factory set to Matrix 4. For help with this step, watch the video "Choosing & Entering Your Patient's Matrix" in the Product Support section of the DAW Website.





1. Turn on the remote by pressing any button.
2. Confirm that the Bluetooth Indicator in the bottom right-hand corner of the remote is solid blue indicating the remote and knee are connected. If the Bluetooth Indicator is blinking, flex the knee a few times until the light remains solid, (see fig. b.)
3. Press and hold the  (A/M) button until the Top Window shows a blinking dot in the lower right-hand corner. The Remote will beep twice.
4. Using the up/down arrows,   scroll to the desired Matrix (1 to 5). See page 8 for help selecting the ideal Matrix for your patient.
5. To enter your selection, press the  (A/M) button once more. The Top Window will show a "0". The Remote will beep twice. Your selection is confirmed.
6. The knee will now perform within your selected matrix. Should you wish to change your selected matrix, repeat steps 3 through 5.

fig. b



SLK Multi-Matrix 2.5™ Knee Proximal Attachments Selector Chart

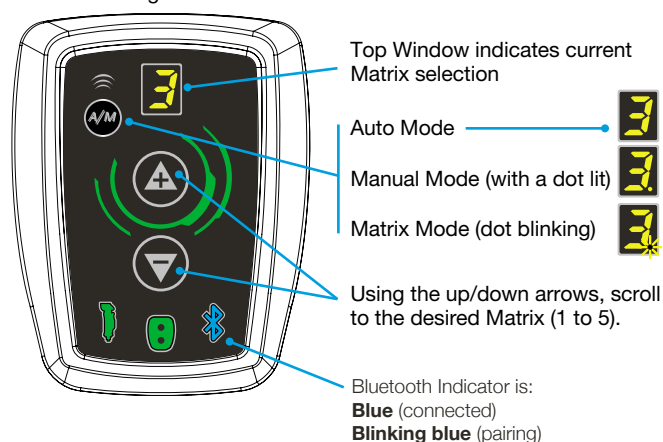
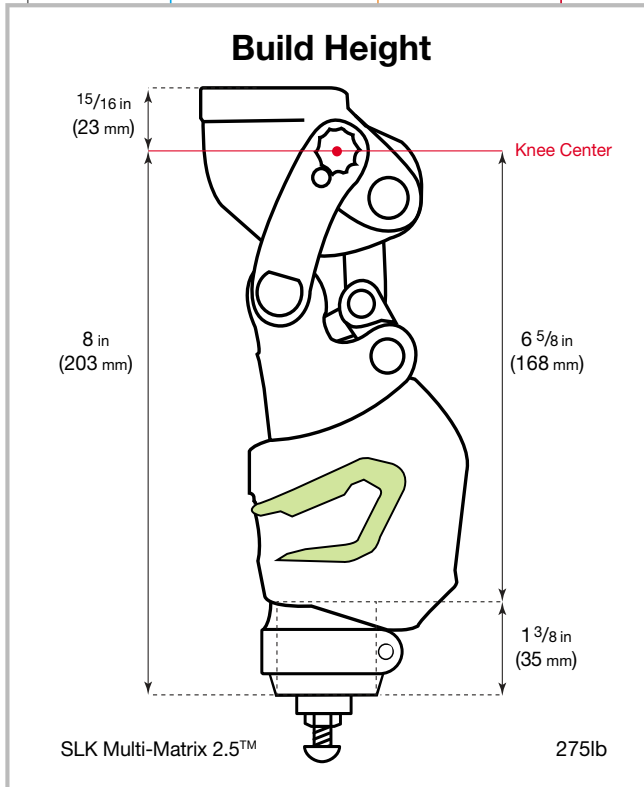
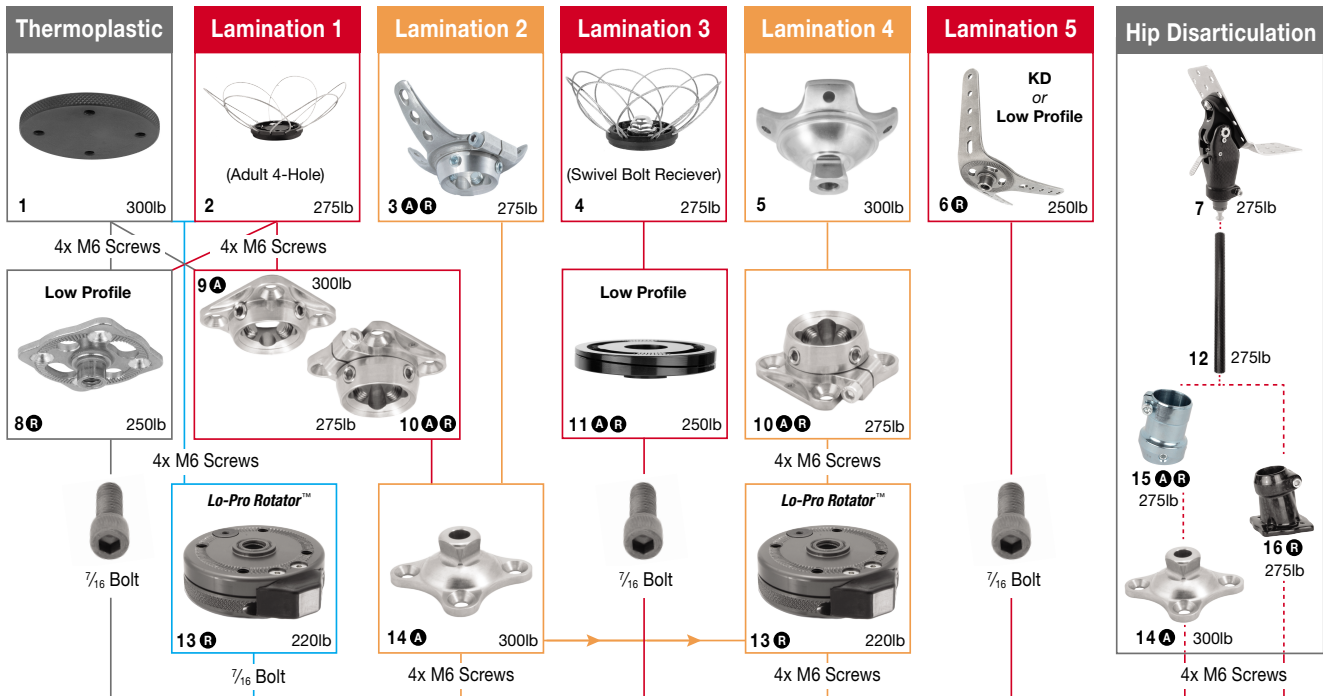

STOCK	MATERIAL	FULL INFO
1	TSC-T	A Pg. 73
2	TSC-BX	AA Pg. 71
3	GUPS-FLAM3PRROT	S Pg. 72
4	TSC-A	AA Pg. 70
5	GUPT-MLAM	T Pg. 71
6	TSC-KDL	S Pg. 70
7	TGH-01	C Pg. 48
8	TSC-PSDS	S Pg. 81
9	GUPT-F4H	T Pg. 77
10	GUPT-F4HROT	T Pg. 77
11	TWP-A2A	AA Pg. 80
12	TTG-14	C Pg. 88
13	TKR-01	A Pg. 80
14	GUPT-M4H	T Pg. 76
15	GUPT-FCLAMP-ANG	T Pg. 82
16	TGC-0A	C Pg. 82

MATERIALS	ADJUSTABILITY
A = Aluminum Alloy	A = Angular
AA = Areospace Aluminum	R = Rotational
C = Carbon Graphite	S = Sliding
S = Stainless Steel	
T = Titanium	